

TEC
NICO

ALPINE SENSOR-62 BÁSICO GU10-36 BORA BORA II-54 BULBS-78



CABRERA
SUPERFICIE-30

HUEZ-58

INTERLAKEN-42

LOGAN-68



MAGNETO MINI-6

MARSALA-26

PAROS-24

POPA-20



PROA-40

QUEBEC LED-70

SHELLA-64

SHIKA-72



SPEAK-32

TARIFA-22

TRIAC
CONTROLLERS-76

ZERMAT-74



ALPINE SENSOR62
 BÁSICO GU1036
 BORA BORA II.....54
 BULBS.....78
 CABRERA SUPERFICIE.....30
 HUEZ58
 INTERLAKEN42
 LOGAN.....68
 MAGNETO MINI06
 MARSALA.....26
 PAROS24
 POPA20
 PROA.....40
 QUEBEC LED70
 SHELLA.....64
 SHIKA72
 SPEAK32
 TARIFA.....22
 TRIAC CONTROLLERS.....76
 ZERMAT74

MAGNETO mini



MAGNETO mini



MAGNETO mini

MAGNETO mini

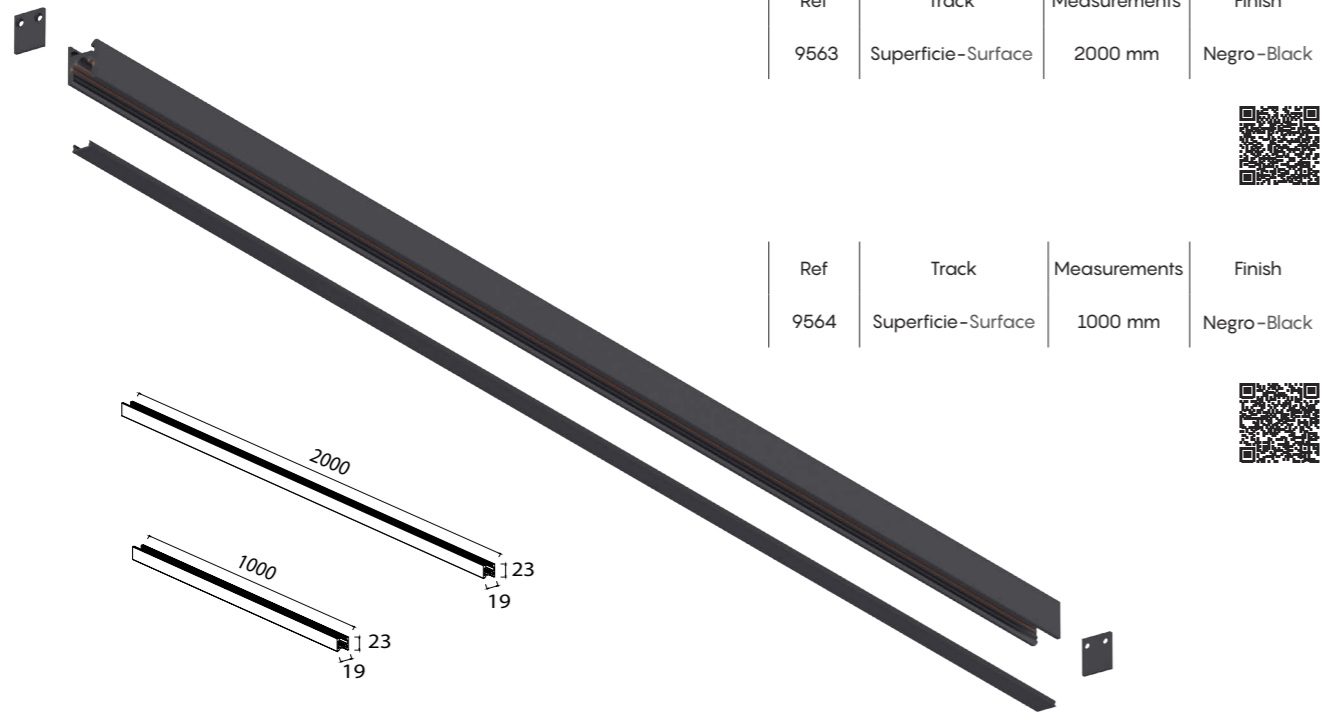

| Ref | Track | Measurements | Finish |
|------|--------------------|--------------|-------------|
| 9563 | Superficie-Surface | 2000 mm | Negro-Black |



| Ref | Track | Measurements | Finish |
|------|--------------------|--------------|-------------|
| 9564 | Superficie-Surface | 1000 mm | Negro-Black |



| Ref | Connection | Angle |
|------|------------|-------|
| 9567 | Recta | 0° |



| Ref | Connection | Wire |
|------|------------|------|
| 9571 | Recto | 2m |

Red +48V
Black - 48V



| Ref | Connection | Angle |
|------|------------|----------|
| 9570 | Flexible | Variable |



| Ref | Connection | Angle |
|------|------------|-------|
| 9568 | L-Out | 90° |



| Ref | Connection | Angle |
|------|------------|-------|
| 9569 | L-Interna | 90° |



| Ref | Connection | Angle | Finish |
|------|------------|-------|-------------|
| 9565 | Out | 90° | Negro-Black |

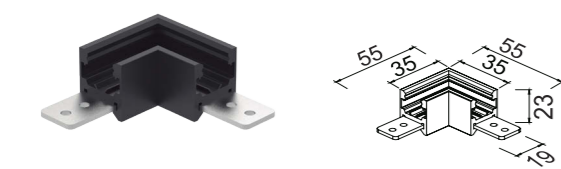

| Ref | Top track | Finish |
|------|------------------|-------------|
| 8303 | Connection plate | Acero-Steel |



| Ref | Connection | Angle | Finish |
|------|------------|-------|-------------|
| 9566 | Interna | 90° | Negro-Black |

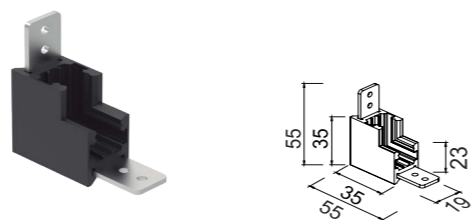

| Ref | Suspension | Wire | Finish |
|------|------------|------|-------------|
| 8377 | Kits | 2 | Negro-Black |

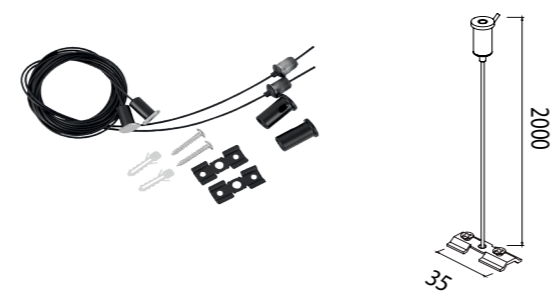

IP20

MAGNETO mini



| Ref | K | Led | Lumens | Angle |
|------|-------|-----|--------|-------|
| 9574 | 3000K | 6W | 500lm | 36° |

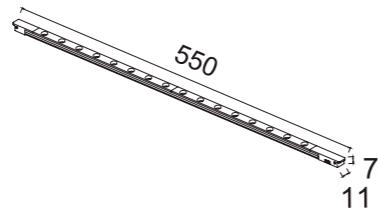
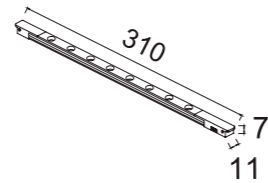
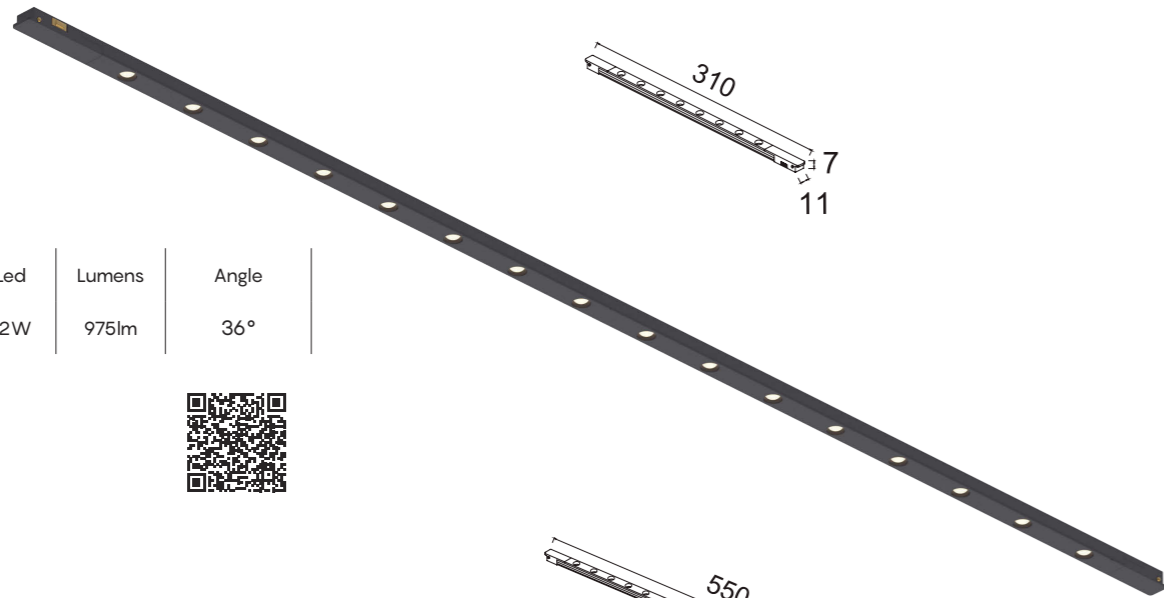

| Ref | K | Led | Lumens | Angle |
|------|-------|-----|--------|-------|
| 9575 | 3000K | 12W | 975lm | 36° |



Finish: Negro-Black

Material: Aluminio-Aluminium

48V CRI≥ 90

MAGNETO mini

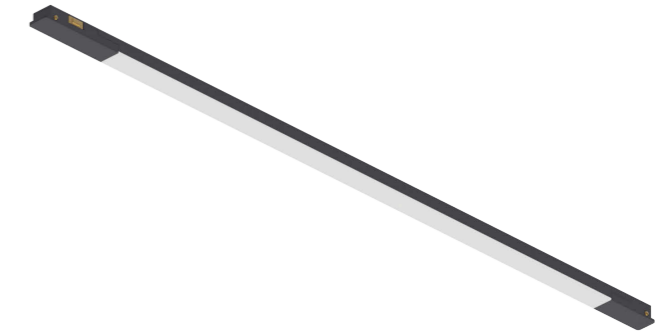

| Ref | K | Led | Lumens | Angle |
|------|-------|-----|--------|-------|
| 9572 | 3000K | 6W | 420lm | 110° |

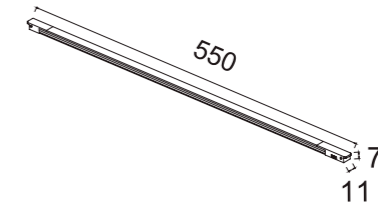
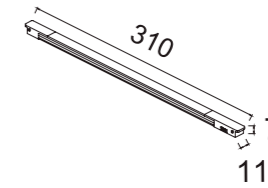
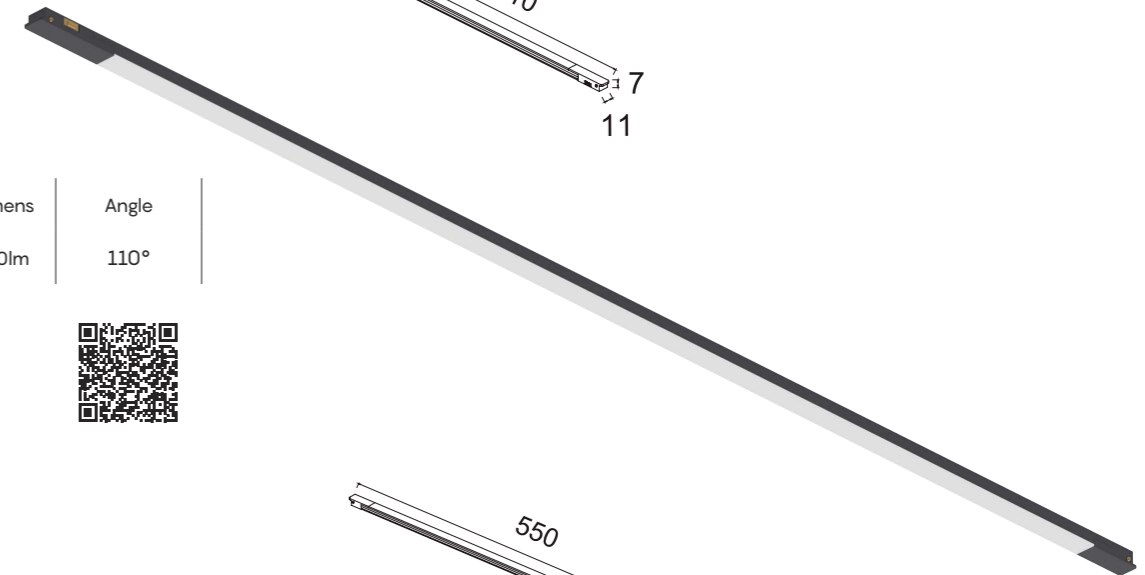

| Ref | K | Led | Lumens | Angle |
|------|-------|-----|--------|-------|
| 9573 | 3000K | 12W | 840lm | 110° |



Finish: Negro-Black

Material: Aluminio-Aluminium

48V CRI≥ 90



MAGNETO mini

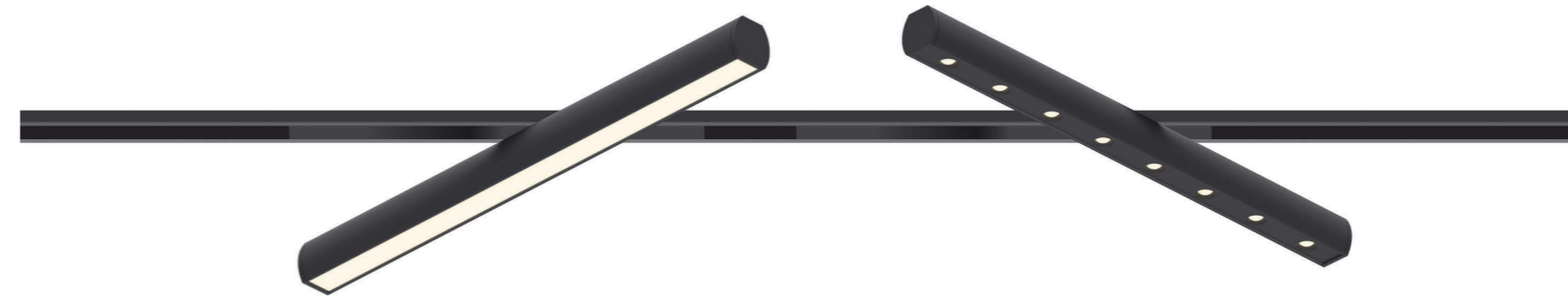

| Ref | K | Led | Lumens | Angle | QR |
|------|-------|-----|--------|-------|----|
| 9576 | 3000K | 6W | 420lm | 110° | |

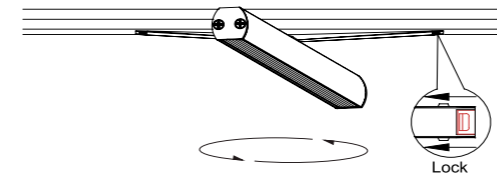

| Ref | K | Led | Lumens | Angle | QR |
|------|-------|-----|--------|-------|----|
| 9577 | 3000K | 6W | 500lm | 36° | |

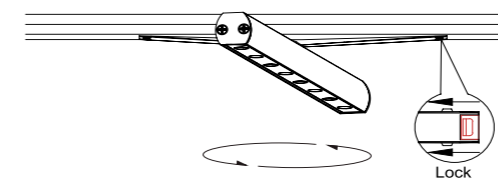

Finish: Negro-Black | Material: Aluminio-Aluminium | 48V CRI≥ 90

MAGNETO mini

| Ref | K | Led | Lumens | Angle |
|------|-------|-----|--------|-------------|
| 9581 | 3000K | 7W | 460lm | Zoom 15-36° |



| Ref | K | Led | Lumens | Angle |
|------|-------|-----|--------|-------------|
| 9580 | 3000K | 7W | 460lm | Zoom 15-36° |

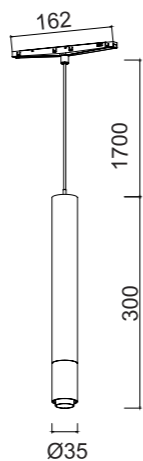
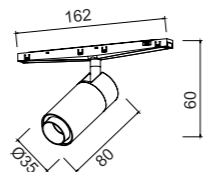
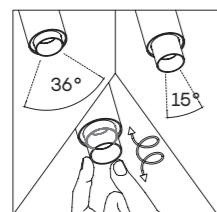

Finish: Negro-Black

Material: Aluminio-Aluminium

48V CRI≥ 90

MAGNETO mini

| Ref | K | Led | Lumens | Angle |
|------|-------|-----|--------|-------|
| 9579 | 3000K | 5W | 400lm | 24° |



| Ref | K | Led | Lumens | Angle |
|------|-------|-----|--------|-------|
| 9578 | 3000K | 5W | 400lm | 24° |

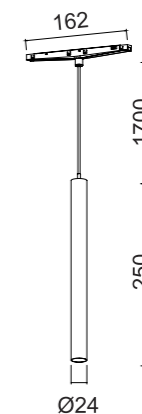
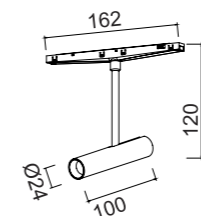

Finish: Negro-Black

Material: Aluminio-Aluminium

48V CRI≥ 90

MAGNETO mini

| Ref | K | Led | Lumens | Angle |
|------|-------|-----|--------|-------|
| 9585 | 3000K | 10W | 800lm | 38° |

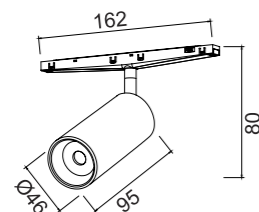

| Ref | K | Led | Lumens | Angle |
|------|-------|-----|--------|-------|
| 9584 | 3000K | 7W | 560lm | 38° |

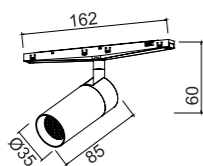

Finish: Negro-Black

Material: Aluminio-Aluminium

48V CRI≥ 90

MAGNETO mini

| Ref | K | Led | Lumens | Angle |
|------|-------|-------|--------|-------|
| 9583 | 3000K | 5W+5W | 800lm | 38° |

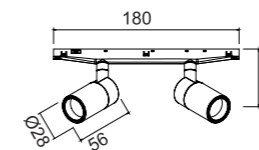

| Ref | K | Led | Lumens | Angle |
|------|-------|-----|--------|-------|
| 9582 | 3000K | 5W | 400lm | 38° |

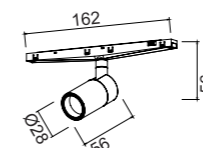

Finish: Negro-Black

Material: Aluminio-Aluminium

48V CRI≥ 90

Alimentadores ocultos-Driver hidden

Tension constante 48V-48V Constant voltage

On/Off

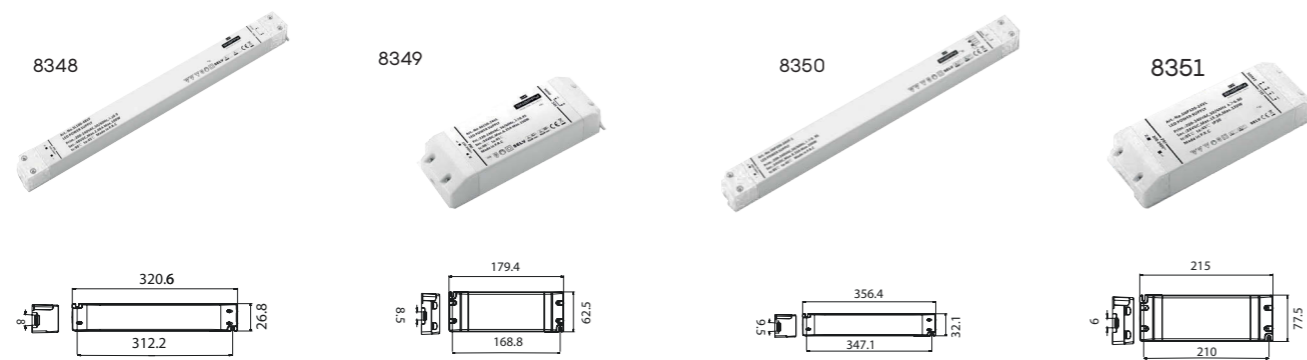

Características técnicas/Technical characteristics

| Ref. | Art.-No | Tensión nominal de entrada Nominal input voltage | Rango de potencia en módulo Output power range | Tensión de salida DC Output voltage DC | Corriente de salida máxima Maximum output current | Factor de potencia Power factor | Frecuencia Frequency | Temp. máx. envolvente Max temp.at tc point | Temp. funcionamiento Operating temp. | Protección Protection |
|------|---------------|---|---|---|--|------------------------------------|-------------------------|---|---|--------------------------|
| | | Vac | W | Vdc | A | λ | Hz | tc (°C) | ta (°C) | IP |
| 8348 | SL100-48VF-1 | 200-240V | 0-100 | 48 | 2.05 | $\geq 0,95$ | 50/60 | 90° | -20...+45° | 20 |
| 8349 | SS150-48VL | 200-240V | 0-150 | 48 | 3.12 | $\geq 0,95$ | 50/60 | 90° | -20...+45° | 20 |
| 8350 | SL240-48VF | 220-240V | 0-240 | 48 | 5.00 | $\geq 0,95$ | 50/60 | 90° | -20...+45° | 20 |
| 8351 | SNP320-48VL-1 | 220-240V | 0-320 | 48 | 6.67 | $\geq 0,95$ | 50/60 | 90° | -20...+45° | 20 |



ON/OFF Ref 9571 + 8348 8349 8350 8351

PUSH TRIAC Ref 9571 + 8347 + 8348 8349 8350 8351

PUSH RF 0-10V Ref 9571 + 9664 + 8348 8349 8350 8351

PUSH DALI Ref 9571 + 9689

Alimentadores ocultos-Driver hidden

Tension constante 48V-48V Constant voltage

DALI PUSH



Características técnicas/Technical characteristics

| Ref. | Art.-No | Tensión nominal de entrada Nominal input voltage | Rango de potencia en módulo Output power range | Tensión de salida DC Output voltage DC | Corriente de salida máxima Maximum output current | Factor de potencia Power factor | Frecuencia Frequency | Temp. máx. envolvente Max temp.at tc point | Temp. funcionamiento Operating temp. | Protección Protection |
|------|---------------|---|---|---|--|------------------------------------|-------------------------|---|---|--------------------------|
| | | Vac | W | Vdc | A | λ | Hz | tc (°C) | ta (°C) | IP |
| 9689 | LF-GHD150D-48 | 148-264V | 0-150 | 48 | 3.125 | $\geq 0,95$ | 50/60 | 90° | -20...+45° | 20 |



Instructions

RF 2.4GHz
0/1-10V.
Push-Dim

SISTEMA REGULACIÓN TENSIÓN CONSTANTE 48v
CONSTANT VOLTAGE DIMMING SYSTEM 48v

V1-T

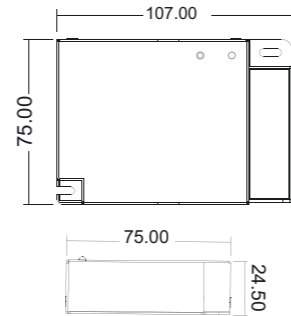

Esquema de Connection/Connection diagram

| Ref. | Input-output Voltage | Tipo de regulación Control signal | Intensidad máx. de salida Max output current | Potencia máx. de salida Max output power | | Control a través de Control made by |
|------|----------------------|-----------------------------------|--|--|----------------------|-------------------------------------|
| | | | | 12V 24V | 36V 48V | |
| | V | mA | A | | | 0-10V |
| 9664 | 12-48VDC | PWM PUSH 0-10V | 20A@12/24V 15A@36/48V | 240W@12V 480W@24V | 540W@36V 720W@48V | RF2.4GHz Ref 9107 Ref 9108 |

Estructuras e Instalaciones Mecánicas/Mechanical Structures and Installations

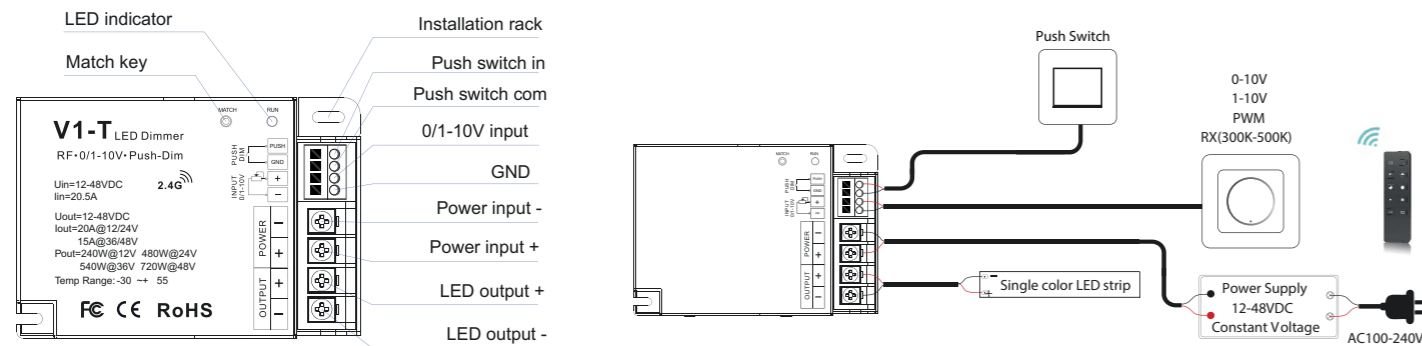

RF 2.4 GHz



Instructions

SISTEMA REGULACIÓN TENSIÓN CONSTANTE TRIAC 48v
48v CONSTANT VOLTAGE DIMMING TRIAC SYSTEM

V1-S

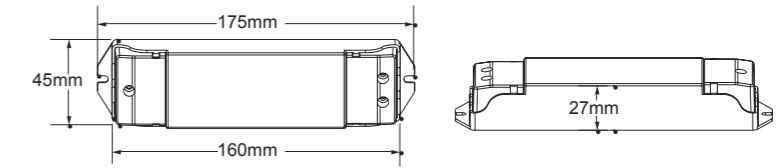

Permite la regulación de tiras led monocolor (12/24/36V) y Trackes magnéticos de 48V.

Puede regular con mecanismos TRIAC y mecanismos pulsadores standard (PUSH).

Puedes conectar varios al mismo mecanismo PUSH; puedes conectar un PUSH y un TRIAC al mismo tiempo.

máx.entrada: 15A/máx.salida: 1 canal de 15A.

Protección contra sobrecargas eléctricas, cortocircuitos y sobrecalentamiento.

Señal entrada regulador AC 40-220v.

Allows to control single color LED strips (12/24/36 V) and 48V magnetic tracks.

Suitable for TRIAC controllers and standard PUSH switches.

You may connect several to the same PUSH switch; also you may connect push switch and TRIAC dimmer at the same time.

max.Input: 15A/max.Output : 1 channel -15A .

Protection against over current, short circuit & over temperature

Input dimmig signal AC 40-220v.

Esquema de Connection/Connection diagram

| Ref. | Input-output Voltage | Tipo de regulación Control signal | Intensidad máx. de salida Max output current | Potencia máx. de salida Max output power | | Tipo tira Led/magnetic Led strip type/magnetic | Control a través de Control made by |
|------|----------------------|-----------------------------------|--|--|--|--|-------------------------------------|
| | | | | 12V 24V 36V 48V | | | |
| | V | mA | A | | | Monocolor | Pulsador standard y/o triac |
| 8347 | 12-48VDC | PWM PUSH TRIAC | 1CH,15A | 180W 360W 540W 720W | | MONOC. DIM (1CH) | Standard push switch and/or triac |

Estructuras e Instalaciones Mecánicas/Mechanical Structures and Installations

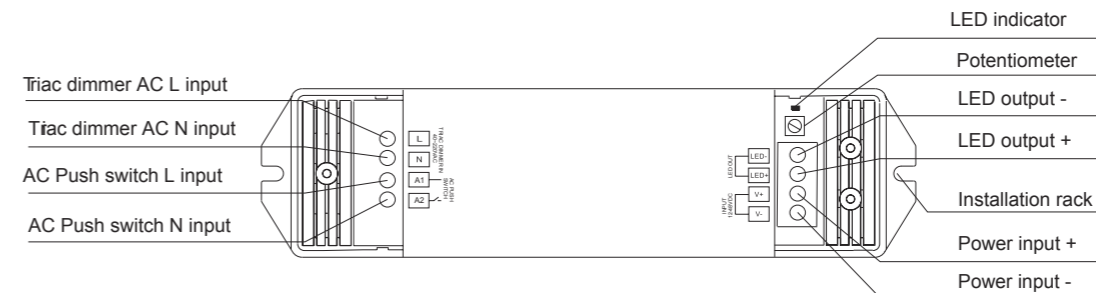

Instructions

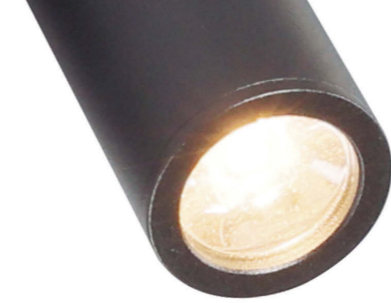

POPA

Aplique lector-Wall lamp reader

| Ref | K | Led | Lumens | Finish |
|------|-------|-----|--------|--------------|
| 9590 | 3000K | 3W | 210lm | Blanco-White |



| Ref | K | Led | Lumens | Finish |
|------|-------|-----|--------|-------------|
| 9591 | 3000K | 3W | 210lm | Negro-Black |



| Ref | K | Led | Lumens | Finish |
|------|-------|-----|--------|----------------------------|
| 9592 | 3000K | 3W | 210lm | Oro cepillado-Brushed gold |

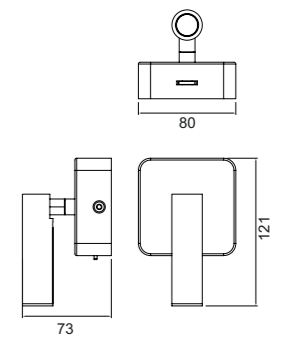

Material: Aluminio-Aluminum

220-240V-50/60Hz CRI:≥ 80



TARIFA

Aplique lector-Wall lamp reader

| Ref | K | Led | Lumens | Finish |
|------|-------|-----|--------|-------------|
| 9593 | 3000K | 3W | 210lm | Negro-Black |

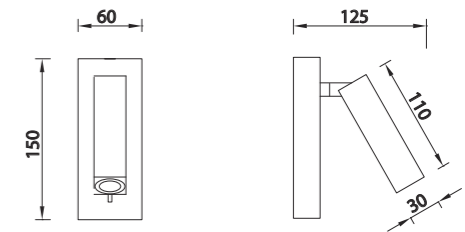

Material: Aluminio-Aluminum

220-240V~50/60Hz CRI:≥ 80



PAROS
Colgante-Pendant lamp

| | | | | | |
|------|-------|---------|--------|-------------|---|
| Ref | K | Led att | Lumens | Finish |  |
| 9597 | 3000K | 5W | 420lm | Negro-Black | |

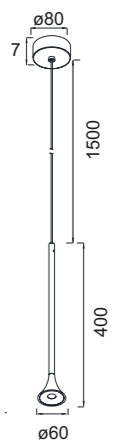

Material: Aluminio-Aluminum

100-240V-50/60Hz CRI:≥ 90



MARSALA

Pie de salón-Floor lamp

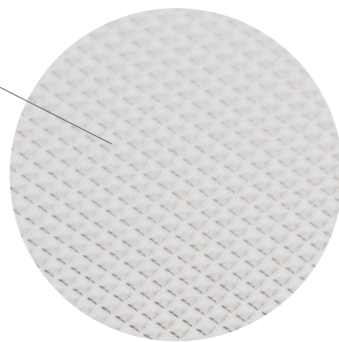
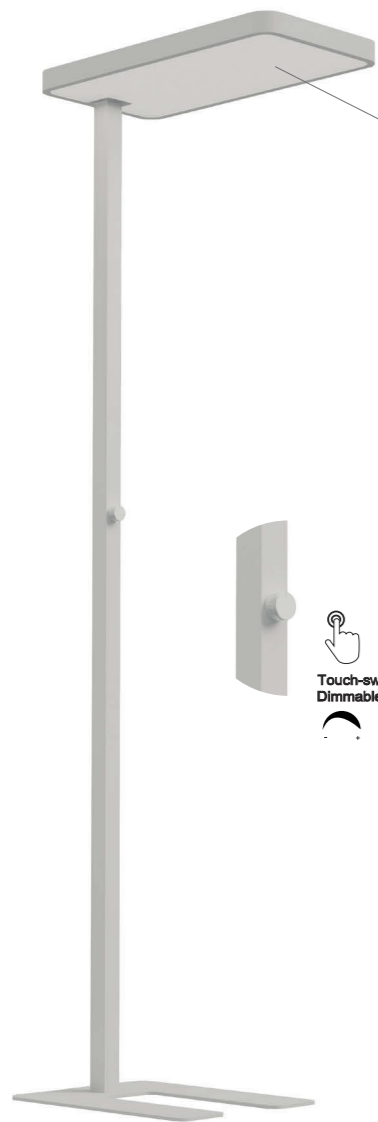

Especial para estudio y oficinas
Specially for study and office use

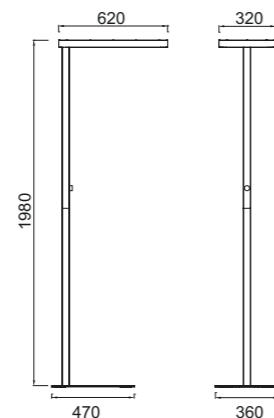

| Ref | K | Led att | Lumens | Finish | |
|------|-------|---------|--------|--------------|---|
| 9556 | 4000K | 55W+45W | 6250lm | Blanco-White |  |





CABRERA SUPERFICIE

Plafón-Ceiling lights

| Ref | K | Led | Lumens | Finish | QR |
|------|-------|-----|--------|--------------|----|
| 9588 | 3000K | 7W | 540lm | Blanco-White | |



| Ref | K | Led | Lumens | Finish | QR |
|------|-------|-----|--------|---------------|----|
| 9589 | 3000K | 7W | 540lm | Arenado-Sandy | |

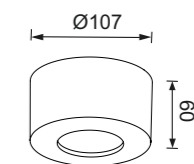

Material: Aluminio-Aluminum

220-240V-50/60Hz CRI:≥ 80



SPEAK MAGNETO

Altavoz bluetooth Track magnético-Magnetic track bluetooth speaker

| Ref | Power | Bluetooth version | Bluetooth distance | Finish | Signal frequency |
|------|-------|-------------------|--------------------|--------------|------------------|
| 9633 | 10W | V5.4 | 10 m | Blanco-White | 12 Db |



| Ref | Power | Bluetooth version | Bluetooth distance | Finish | Signal frequency |
|------|-------|-------------------|--------------------|-------------|------------------|
| 9634 | 10W | V5.4 | 10 m | Negro-Black | 12 Db |

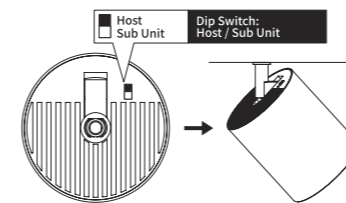
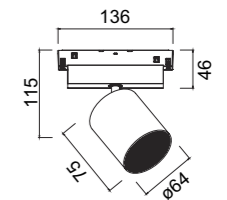

Los dispositivos Bluetooth se conectan al modo Host, y los modos Track Bluetooth Speaker y otros subunidades se sincronizan y conectan automáticamente.

Bluetooth device connect to the Host mode, Track Bluetooth Speaker and other Sub Unit modes automatically synchronize and connect.

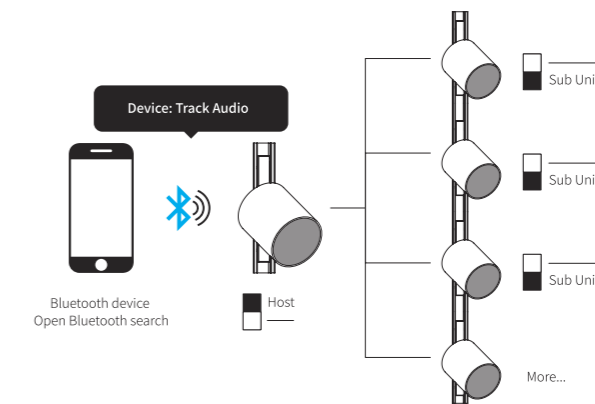

Instructions



INSTALAR



Material: Aluminio-Aluminum

DC48V



SPEAK TRIFÁSICO

Altavoz bluetooth Track trifásico-Triphasic track bluetooth speaker



| Ref | Power | Bluetooth version | Bluetooth distance | Finish | Signal frequency |
|------|-------|-------------------|--------------------|--------------|------------------|
| 9631 | 10W | V5.4 | 10 m | Blanco-White | 12 Db |



| Ref | Power | Bluetooth version | Bluetooth distance | Finish | Signal frequency |
|------|-------|-------------------|--------------------|-------------|------------------|
| 9632 | 10W | V5.4 | 10 m | Negro-Black | 12 Db |

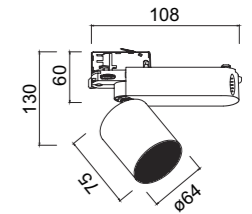
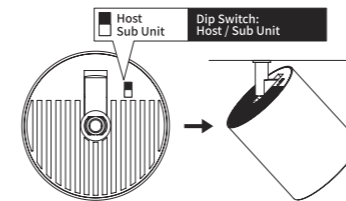

Los dispositivos Bluetooth se conectan al modo Host, y los modos Track Bluetooth Speaker y otros subunidades se sincronizan y conectan automáticamente.

Bluetooth device connect to the Host mode, Track Bluetooth Speaker and other Sub Unit modes automatically synchronize and connect.

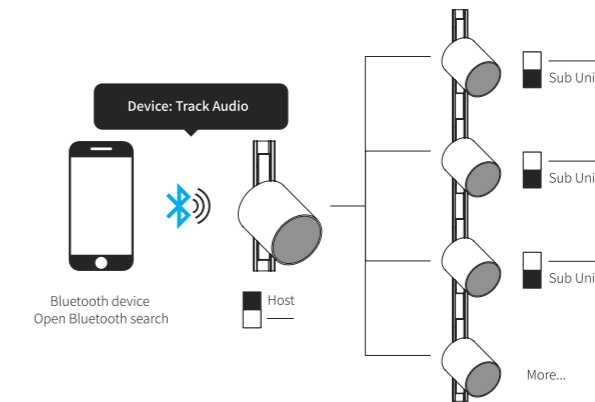

Instructions



INSTALAR



Material: Aluminio-Aluminum

220-240V-50/60Hz



BÁSICO GU10

Empotrable-Recessed

| | | | |
|------|-----------------|-------------------------|---------------|
| Ref | BULB (Not incl) | | Finish |
| 9606 | 1L x GU10 | máx. 12W LED (Not incl) | Arenado-Sandy |

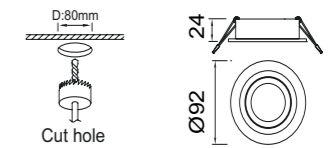

Bombillas recomendadas - Suggested bulbs

| K | W LED | On/Off | Dimmable | Lumen |
|-------|-------|--------|----------|-------|
| 2700K | 7W | R09254 | R09257 | 510lm |
| 3000K | 7W | R09255 | R09258 | 540lm |
| 4000K | 7W | R09256 | R09259 | 570lm |



Material: Aluminio-Aluminum

100-240V-50/60Hz



BÁSICO GU10

Empotrable-Recessed

| | | | |
|------|-----------------|-------------------------|--------------|
| Ref | BULB (Not incl) | | Finish |
| 9586 | 2L x GU10 | máx. 12W LED (Not incl) | Blanco-White |



| | | | |
|------|-----------------|-------------------------|-------------|
| Ref | BULB (Not incl) | | Finish |
| 9587 | 2L x GU10 | máx. 12W LED (Not incl) | Negro-Black |

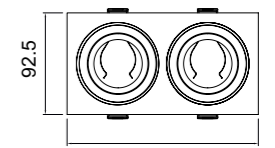
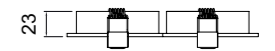

174

Bombillas recomendadas-Suggested bulbs

| K | W LED | On/Off | Dimmable | Lumen |
|-------|-------|--------|----------|-------|
| 2700K | 7W | R09254 | R09257 | 510lm |
| 3000K | 7W | R09255 | R09258 | 540lm |
| 4000K | 7W | R09256 | R09259 | 570lm |



Material: Aluminio-Aluminum

100-240V-50/60Hz



PROA SENSOR

Señalizadores empotrables-Recessed step wall lights

| Ref | K | Led | Lumens | Finish |
|------|-------|-----|--------|--------------|
| 9594 | 3000K | 3W | 180lm | Blanco-White |



| Ref | K | Led | Lumens | Finish |
|------|-------|-----|--------|-------------|
| 9595 | 3000K | 3W | 180lm | Negro-Black |



| Ref | K | Led | Lumens | Finish |
|------|-------|-----|--------|-----------------------|
| 9596 | 3000K | 3W | 180lm | verde gris-Grey green |

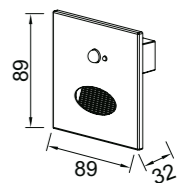
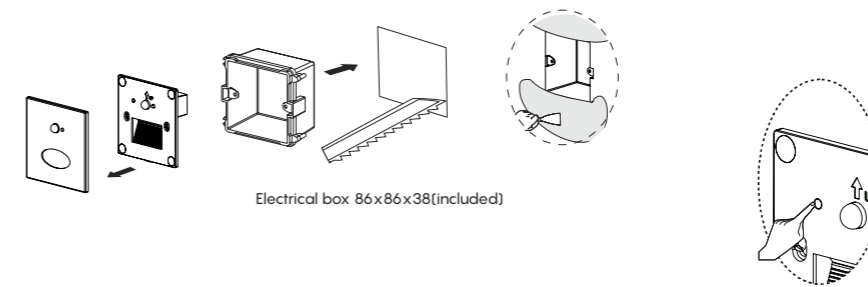

MODE SWITCHING

1. Constant light mode: press once - flash once.
2. Infrared sensing mode: press twice - the lamp flashes twice
3. Infrared + photosensitive mode: press three times - the lamp flashes three times

CAMBIO DE MODO

1. Modo de luz constante: pulse una vez - parpadea una vez
2. Modo de detección infrarroja: pulse dos veces - la lámpara parpadea dos veces
3. Modo infrarrojo + fotosensible: pulse tres veces - la lámpara parpadea tres veces

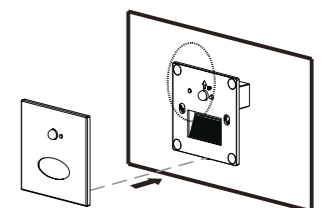

instructions



INTERLAKEN

Baliza exterior-Bollard outdoor

| | | | | |
|------|------------------------|-------------|-----------------------------------|---|
| Ref | BULB (Not incl) | Finish | Material |  |
| 9607 | 1L x G9 máx. 5W LED | Negro-Black | Aluminio/Vidrio Aluminum/Glass | |



REF-9607

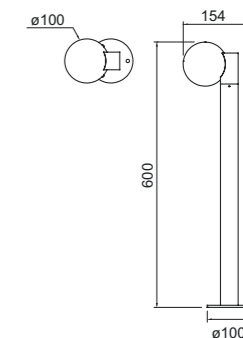

| K | W LED | Ref | Lumen | Dimmable |
|-------|-------|--------|-------|----------|
| 2700K | 4,4W | R09298 | 470lm | Dimmable |
| 3000K | 4,4W | R09299 | 500lm | Dimmable |
| 3000K | 4,5W | R09300 | 520lm | On/Off |
| 4000K | 4,5W | R09301 | 550lm | On/Off |

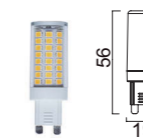

Bombillas recomendadas-Suggested bulbs



100-240V-50/60Hz

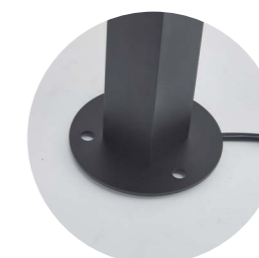



INTERLAKEN

Plafón exterior-Outdoor ceiling lamps

| | | | | |
|------|------------------------|-------------|-----------------------------------|---|
| Ref | BULB (Not incl) | Finish | Material |  |
| 9608 | 1L x G9 máx. 5W LED | Negro-Black | Aluminio/Vidrio Aluminum/Glass | |

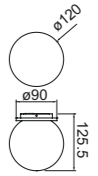

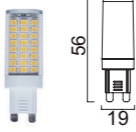
| K | W LED | Ref | Lumen | Dimmable |  |
|-------|-------|--------|-------|----------|---|
| 2700K | 4,4W | R09298 | 470lm | Dimmable | |
| 3000K | 4,4W | R09299 | 500lm | Dimmable | |
| 3000K | 4,5W | R09300 | 520lm | On/Off | |
| 4000K | 4,5W | R09301 | 550lm | On/Off | |

Bombillas recomendadas-Suggested bulbs



100-240V-50/60Hz





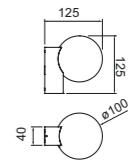

INTERLAKEN

Aplique exterior-Outdoor wall lamp

| | | | | |
|------|------------------------|-------------|-----------------------------------|---|
| Ref | BULB (Not incl) | Finish | Material |  |
| 9609 | 1L x G9 máx. 5W LED | Negro-Black | Aluminio/Vidrio Aluminum/Glass | |



| | K | W LED | Ref | Lumen | |
|---|-------|-------|--------|-------|----------|
|  | 2700K | 4,4W | R09298 | 470lm | Dimmable |
|  | 3000K | 4,4W | R09299 | 500lm | Dimmable |
|  | 3000K | 4,5W | R09300 | 520lm | On/Off |
|  | 4000K | 4,5W | R09301 | 550lm | On/Off |

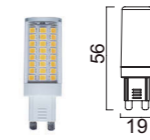

Bombillas recomendadas-Suggested bulbs



100-240V-50/60Hz







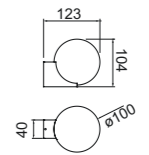

INTERLAKEN

Aplique exterior-Outdoor wall lamp

| | | | | |
|------|------------------------|-------------|-----------------------------------|---|
| Ref | BULB (Not incl) | Finish | Material |  |
| 9610 | 1L x G9 máx. 5W LED | Negro-Black | Aluminio/Vidrio Aluminum/Glass | |



| | K | W LED | Ref | Lumen | |
|---|-------|-------|--------|-------|----------|
|  | 2700K | 4,4W | R09298 | 470lm | Dimmable |
|  | 3000K | 4,4W | R09299 | 500lm | Dimmable |
|  | 3000K | 4,5W | R09300 | 520lm | On/Off |
|  | 4000K | 4,5W | R09301 | 550lm | On/Off |

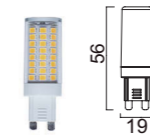

Bombillas recomendadas-Suggested bulbs



100-240V-50/60Hz



INTERLAKEN

Aplique exterior-Outdoor wall lamp

| | | | | |
|------|------------------------|-------------|-----------------------------------|---|
| Ref | BULB (Not incl) | Finish | Material |  |
| 9611 | 2L x G9 máx. 5W LED | Negro-Black | Aluminio/Vidrio Aluminum/Glass | |

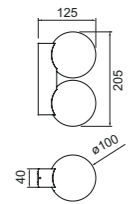

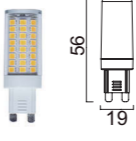
| K | W LED | Ref | Lumen | Dimmable |  |
|-------|-------|--------|-------|----------|---|
| 2700K | 4,4W | R09298 | 470lm | Dimmable | |
| 3000K | 4,4W | R09299 | 500lm | Dimmable | |
| 3000K | 4,5W | R09300 | 520lm | On/Off | |
| 4000K | 4,5W | R09301 | 550lm | On/Off | |

Bombillas recomendadas-Suggested bulbs

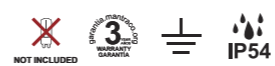

100-240V-50/60Hz



INTERLAKEN

Aplique exterior-Outdoor wall lamp

| | | | | |
|------|------------------------|-------------|-----------------------------------|---|
| Ref | BULB (Not incl) | Finish | Material |  |
| 9612 | 1L x G9 máx. 5W LED | Negro-Black | Aluminio/Vidrio Aluminum/Glass | |

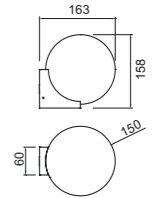

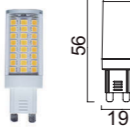
| K | W LED | Ref | Lumen | Dimmable |  |
|-------|-------|--------|-------|----------|---|
| 2700K | 4,4W | R09298 | 470lm | Dimmable | |
| 3000K | 4,4W | R09299 | 500lm | Dimmable | |
| 3000K | 4,5W | R09300 | 520lm | On/Off | |
| 4000K | 4,5W | R09301 | 550lm | On/Off | |

Bombillas recomendadas-Suggested bulbs



100-240V-50/60Hz



BORA BORA II

Aplique exterior-Outdoor wall lamp

| Ref | K | Led | Lumens | Finish |
|------|-------|-----|--------|-------------|
| 9625 | 3000K | 10W | 700lm | Negro-Black |

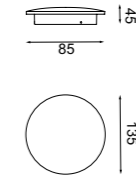

| Ref | K | Led | Lumens | Finish |
|------|-------|-----|--------|-------------|
| 9626 | 3000K | 15W | 1050lm | Negro-Black |

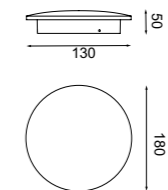

| Ref | K | Led | Lumens | Finish |
|------|-------|-----|---------|-------------|
| 9627 | 3000K | 20W | 1 400lm | Negro-Black |

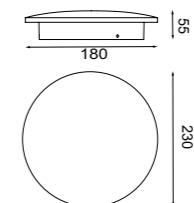

Material: Aluminio-Aluminum

220-240V-50/60Hz CRI:≥ 80



BORA BORA II

Aplique exterior-Outdoor wall lamp

| Ref | K | Led | Lumens | Finish |
|------|-------|-----|--------|--------------|
| 9628 | 3000K | 10W | 700lm | Blanco-White |

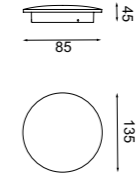

| Ref | K | Led | Lumens | Finish |
|------|-------|-----|--------|--------------|
| 9629 | 3000K | 15W | 1050lm | Blanco-White |

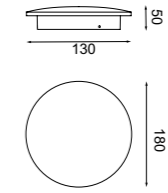

| Ref | K | Led | Lumens | Finish |
|------|-------|-----|---------|--------------|
| 9630 | 3000K | 20W | 1 400lm | Blanco-White |

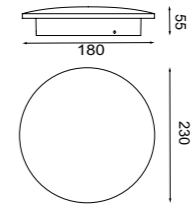

Material: Aluminio-Aluminum

220-240V-50/60Hz CRI:≥ 80



HUEZ

Aplique exterior-Outdoor wall lamp

| Ref | K | Led | Lumens | Finish |
|------|-------|-----|--------|-------------|
| 9619 | 3000K | 5W | 400lm | Negro-Black |



| Ref | K | Led | Lumens | Finish |
|------|-------|-----|--------|--------------|
| 9620 | 3000K | 5W | 400lm | Blanco-White |



| Ref | K | Led | Lumens | Finish |
|------|-------|-----|--------|---------------|
| 9621 | 3000K | 5W | 400lm | Corten-Corten |

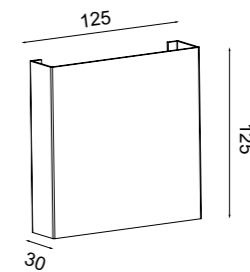
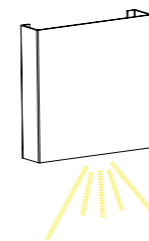

Material: Aluminio-Aluminum

100-240V-50/60Hz CRI:≥ 90



HUEZ

Aplique exterior-Outdoor wall lamp

| Ref | K | Led | Lumens | Finish |
|------|-------|-----|--------|-------------|
| 9622 | 3000K | 10W | 800lm | Negro-Black |

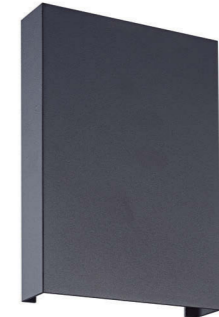

| Ref | K | Led | Lumens | Finish |
|------|-------|-----|--------|--------------|
| 9623 | 3000K | 10W | 800lm | Blanco-White |



| Ref | K | Led | Lumens | Finish |
|------|-------|-----|--------|---------------|
| 9624 | 3000K | 10W | 800lm | Corten-Corten |

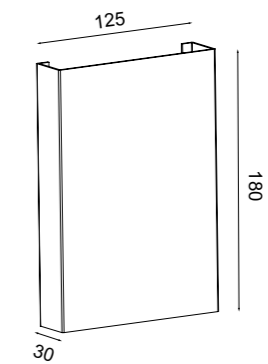

Material: Aluminio-Aluminum

100-240V-50/60Hz CRI:≥ 90



ALPINE SENSOR

Aplique exterior-Outdoor wall lamp

| Ref | K | Led | Lumens | Finish |
|------|-------|-----|--------|-----------------------|
| 9613 | 3000K | 7W | 590lm | Gris Oscuro-Dark Grey |



| Ref | K | Led | Lumens | Finish |
|------|-------|-----|--------|--------------|
| 9614 | 3000K | 7W | 590lm | Blanco-White |

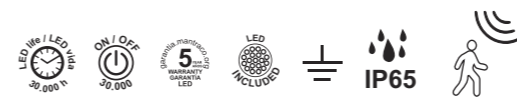
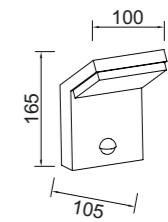
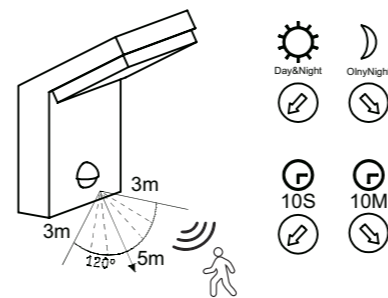

Material: Aluminio-Aluminum

220-240V-50/60Hz CRI:≥ 80



SHELLA

Señalizador superficie-Step wall lamp

| Ref | K | Led | Lumens | Finish | QR |
|------|-------|-----|--------|--------------|----|
| 9603 | 3000K | 3W | 180lm | Blanco-White | |



| Ref | K | Led | Lumens | Finish | QR |
|------|-------|-----|--------|-------------|----|
| 9604 | 3000K | 3W | 180lm | Negro-Black | |

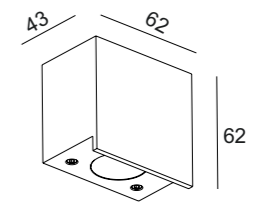

Material: Aluminio-Aluminum | 100-240V-50/60Hz CRI:≥ 90

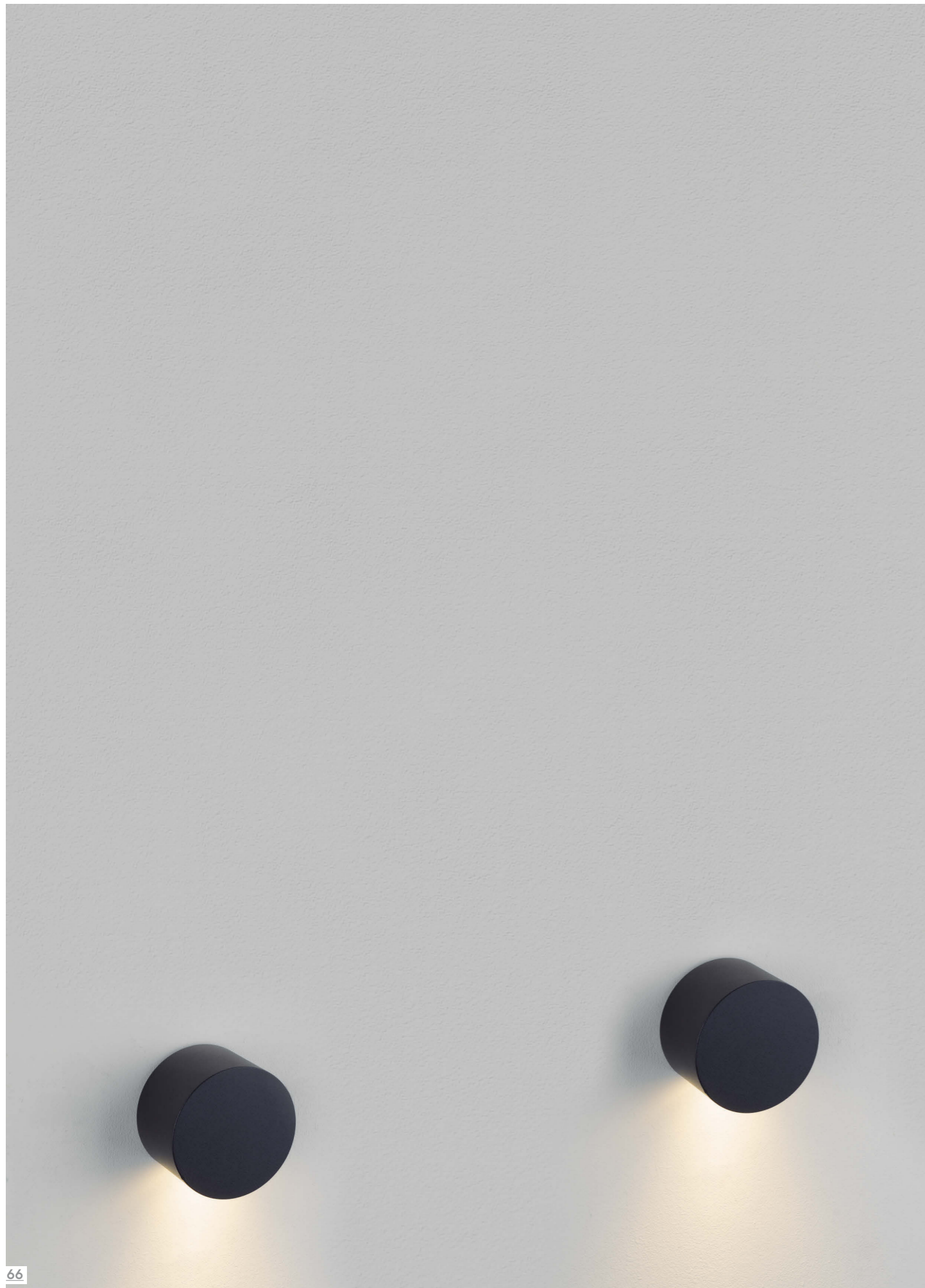

SHELLA

Señalizador superficie-Step wall lamp

| Ref | K | Led | Lumens | Finish | QR |
|------|-------|-----|--------|--------------|---|
| 9601 | 3000K | 3W | 180lm | Blanco-White |  |

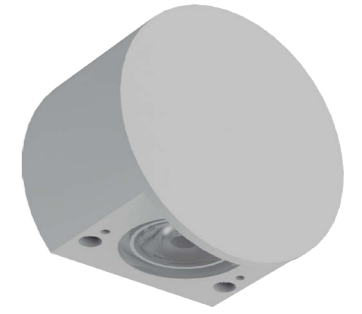

| Ref | K | Led | Lumens | Finish | QR |
|------|-------|-----|--------|-------------|--|
| 9602 | 3000K | 3W | 180lm | Negro-Black |  |

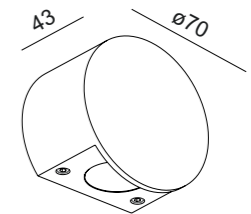

Material: Aluminio-Aluminum

100-240V-50/60Hz CRI:≥ 90



LOGAN

Foco de suelo-Spotlight floor

| Ref | K | Led att | Lumens | Finish | QR |
|------|-------|---------|--------|-----------------------|----|
| 9599 | 3000K | 6W | 525lm | Gris oscuro-Dark grey | |



| Ref | K | Led att | Lumens | Finish | QR |
|------|-------|---------|--------|-----------------|----|
| 9600 | 3000K | 6W | 525lm | Negro-Dark grey | |

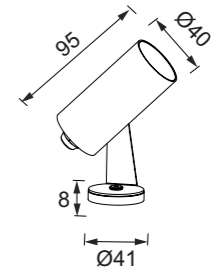

Material: Aluminio-Aluminum

100-240V-50/60Hz CRI:≥ 90



QUEBEC LED 10W

Piqueta exterior - Outdoor spike

| Ref | K | Led | Lumens | Finish |
|------|-------|-----|--------|-------------|
| 9615 | 3000K | 10W | 1100lm | Negro-Black |



| Ref | K | Led | Lumens | Finish |
|------|-------|-----|--------|-----------------------|
| 9616 | 3000K | 10W | 1100lm | Gris Oscuro-Dark Grey |



| Ref | K | Led | Lumens | Finish |
|------|-------|-----|--------|---------------|
| 9617 | 3000K | 10W | 1100lm | Corten-Corten |

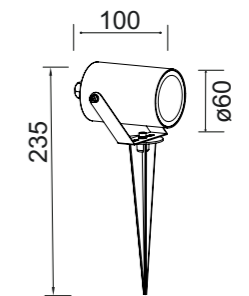

Material: Aluminio-Aluminum | 100-240V-50/60Hz CRI:≥ 90



SHIKA

Empotrable suelo-Recessed floor

| Ref | K | Led | Lumens | Finish |
|------|-------|-----|--------|-----------------------|
| 9598 | 3000K | 6W | 375lm | Acero-Stainless steel |

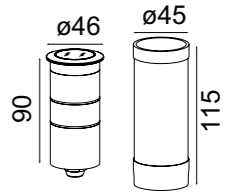

Material: Aluminio-Aluminum

220-240V-50/60Hz CRI:≥ 80

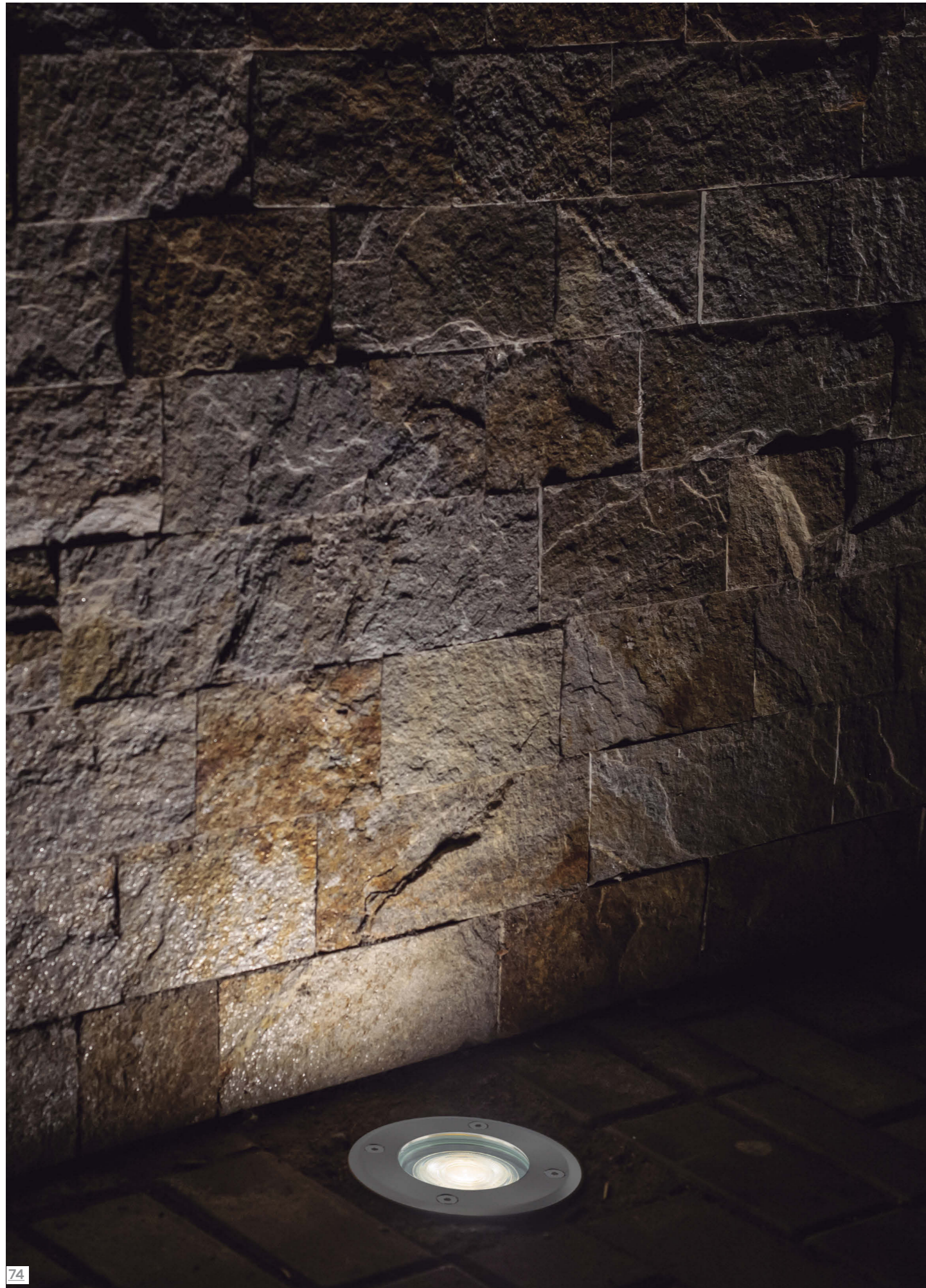

ZERMAT

Luz suelo-Ground floor

| | | |
|------|---------------------------|-----------------------|
| Ref | BULB (Not incl) | Finish |
| 9618 | 1L x GU10 máx. 12W LED | Acero-Stainless steel |

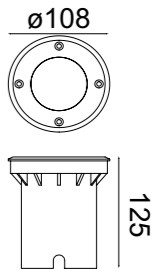

Bombillas recomendadas - Suggested bulbs

| K | W LED | On/Off | Dimmable | Lumen |
|-------|-------|--------|----------|-------|
| 2700K | 7W | R09254 | R09257 | 510lm |
| 3000K | 7W | R09255 | R09258 | 540lm |
| 4000K | 7W | R09256 | R09259 | 570lm |

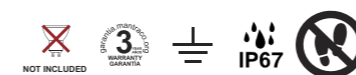

Material: Aluminio-Aluminum

100-240V-50/60Hz

CONTROLADORES/CONTROLLERS
AC TRIAC RF PUSH DIMMER

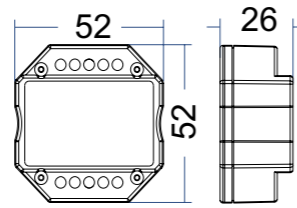

| | | | | | |
|------|----------------------|-------|--------------|-------------------|--|
| Ref | Input signal | Dimer | Finish | Material | |
| 9662 | RF 2.4GHz + Push Dim | TRIAC | Blanco-White | Aluminio-Aluminum | |

- Regulador RF + Push AC de corte de fase, con 1 canal de salida.
- Permite regular y encender/apagar lámparas LED regulables de un solo color, así como luces incandescentes y halógenas tradicionales.
- 256 niveles de regulación (0-100%) con transición suave sin parpadeos.
- Regulación por corte de fase ascendente (leading edge) o descendente (trailing edge), configurable mediante interruptor DIP.
- El brillo mínimo puede ajustarse mediante tecla.
- Tiempo de encendido/apagado gradual de 3 segundos seleccionable.
- Compatible con mandos a distancia RF de 2,4G de una o varias zonas.
- Permite Connection con pulsador externo para funciones de encendido/apagado y regulación de 0-100%.
- Fácil de instalar en una caja de empotrar estándar detrás de un pulsador.
- Protección contra sobrecalentamiento y sobrecarga, con recuperación automática.

- RF + Push AC phase-cut dimmer, 1 channel output.
- To dim and switch single color dimmable LED lamps, traditional incandescent and halogen lights.
- 256 levels 0-100% dimming smoothly without any ash.
- Leading edge dimming or trailing edge dimming set by dip switch.
- Min brightness can be set by key.
- Light on/off fade time 3s selectable.
- Compatibility with RF 2.4G single zone or multiple zone dimming remote control.
- Connect with external push switch to achieve on/off and 0-100% dimming function.
- Easy to be placed in standard wall junction box behind a push switch.
- Over-heat/Over-load protection, recover automatically.

CONTROLADORES/CONTROLLERS
AC TRIAC RF PUSH TUYA

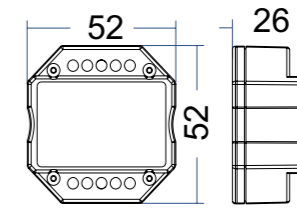
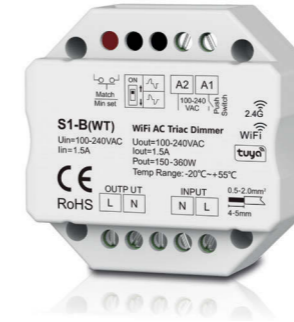

| | | | | | |
|------|----------------------|-------|--------------|-------------------|--|
| Ref | Input signal | Dimer | Finish | Material | |
| 9663 | WiFi + RF + Push Dim | TRIAC | Blanco-White | Aluminio-Aluminum | |

- Regulador AC de corte de fase WiFi + RF + Push, con 1 canal de salida.
- Control en la nube mediante la app inteligente Tuya: admite encendido/apagado, ajuste de brillo, encendido/apagado con retardo, temporizador y funciones de escena.
- Control por voz: compatible con Amazon Alexa, Google Assistant, Tmall Genie y el asistente de voz Xiaodu.
- Cada controlador S1-B(WT) también puede funcionar como convertidor WiFi-RF, permitiendo usar la app Tuya para controlar de forma sincronizada uno o varios controladores o drivers LED RF regulables.
- Permite Connection con pulsador externo para funciones de encendido/apagado y regulación de 0-100%.
- Fácil de instalar en una caja de empotrar estándar detrás de un pulsador.
- Protección contra sobrecalentamiento y sobrecarga, con recuperación automática.

- WiFi + RF + Push AC phase-cut dimmer, 1 channel output.
- Tuya smart APP cloud control, support on/off, brightness adjust, delay turn on/off light, timer run, scene function.
- Voice control, support for Amazon Alexa, Google Assistant, Tmall Genie and Xiaodu voice assistant.
- Each S1-B(WT) controller can also work as WiFi-RF converter, then use Tuya smart APP to control one or more RF dimming LED controller or driver synchronously.
- Connect with external push switch to achieve on/off and 0-100% dimming function.
- Easy to be placed in standard wall junction box behind a push switch.
- Over-heat/Over-load protection, recover automatically.

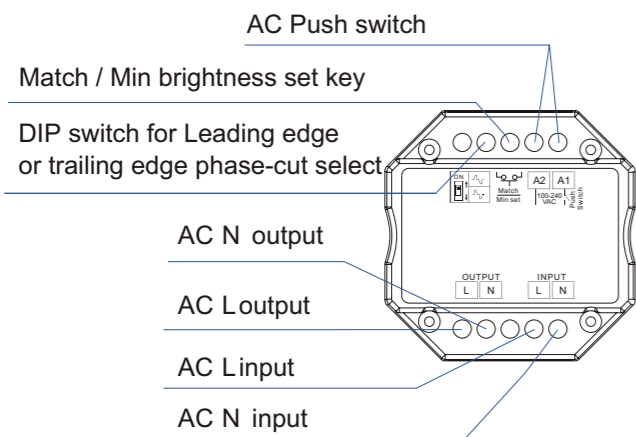

Compatible con/ Compatible with



INSTRUCTIONS

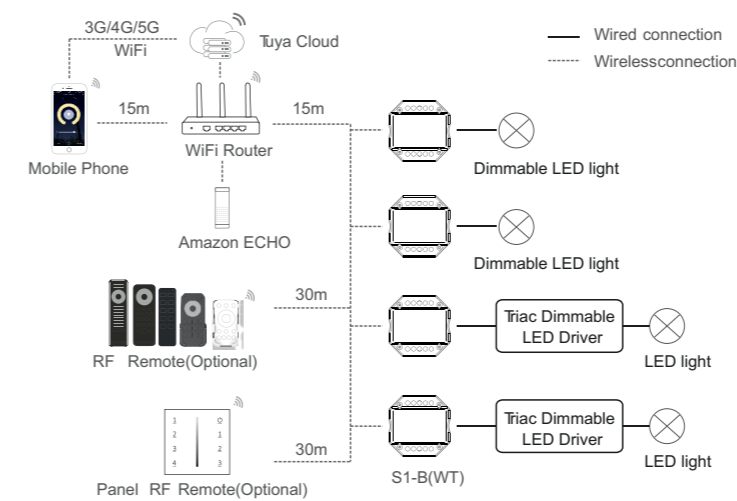

Compatible con/ Compatible with



INSTRUCTIONS

BULB E14 DIM 4W

LED E14 bulb

Características

- * Voltaje: AC 220-240V 50/60Hz 23mA
- * 15,000 hrs. Vida útil
- * Encendido instantáneo con potencia total
- * Perfecta para reemplazar la bombilla incandescente de 40W
- * Baja temperatura al tacto
- * Libre de mercurio, libre de emisión UV & IR
- * Esta bombilla no es idónea para la iluminación de acentuación

Features

- * Voltage: AC 220-240V 50/60Hz 23mA
- * 15,000hrs long life time
- * Instant start with full bright output flick free
- * Perfect replacement for 40W incandescent bulb
- * Low temperature, safety to touch
- * No UV or IR emission, mercury FREE
- * This bulb is not suitable for accent lighting

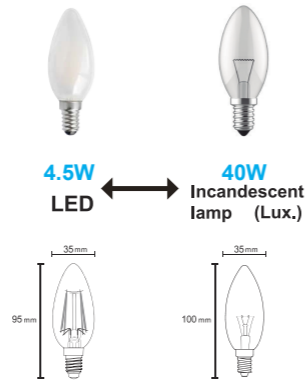

4.5W E14 450 Lumen Dim



| Item No. | R09297 |
|----------------------------------|---------------------------------|
| Potencia nominal/Wattage(W) | 4.5 |
| Temperatura de color/CCT(K) | 3000K |
| Flujo luminoso/Luminous Flux(lm) | 450 |
| Tensión nominal/Voltage(V) | AC 220-240V 50/60Hz |
| Regulable/Dimmable | YES |
| CRI | ≥80 |
| Casquillo/Lamp Head | E14 |
| Ángulo/Beam Angle(deg) | 360° |
| Material | Aluminio+Cristal/Aluminum+Glass |
| Dimensiones/Dimensions(mm) | 35*95 |

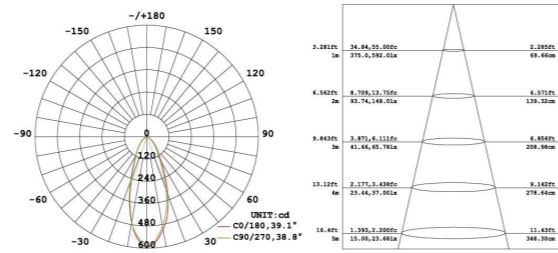

BULB G9

LED G9 Bulb

Características

- * Voltaje: AC 220-240V 50/60Hz 22mA
- * 20,000 hrs. vida útil
- * Encendido instantáneo con potencia total
- * Perfecta para reemplazar la bombilla incandescente de 45W
- * Baja temperatura al tacto
- * Libre de mercurio, Libre de emisión UV & IR
- * Esta lámpara no es idónea para la iluminación de acentuación

Features

- * Voltage: AC 220-240V 50/60Hz 22mA
- * 20,000hrs long life time
- * Instant start with full bright output flick free
- * Perfect replacement for 45W incandescent Bulb
- * Low temperature, safety to touch
- * No UV or IR emission, mercury FREE
- * This lamp is not suitable for accent lighting

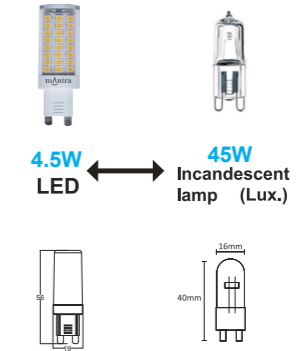

4.4W G9 470 Lumen



| Item No. | R09298 | R09299 |
|----------------------------------|---------------------|--------|
| Potencia nominal/Wattage(W) | 4.4 | 4.4 |
| Temperatura de color/CCT(K) | 2700K | 3000K |
| Flujo luminoso/Luminous Flux(lm) | 470 | 200 |
| Tensión nominal/Voltage(V) | AC 220-240V 50/60Hz | |
| Regulable/Dimmable | YES | |
| CRI | ≥80 | |
| Casquillo/Lamp Head | G9 | |
| Ángulo/Beam Angle(deg) | 360° | |
| Material | PC | |
| Dimensiones/Dimensions(mm) | Φ19*56 | |

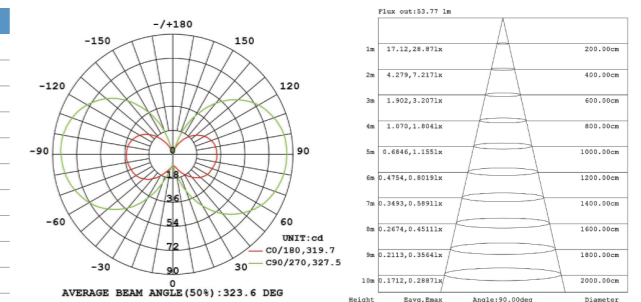

LED G9 Bulb

Características

- * Voltaje: AC 220-240V 50/60Hz 35mA
- * 20,000 hrs. vida útil
- * Encendido instantáneo con potencia total
- * Perfecta para reemplazar la bombilla incandescente de 50W
- * Baja temperatura al tacto
- * Libre de mercurio, Libre de emisión UV & IR
- * Esta lámpara no es idónea para la iluminación de acentuación

Features

- * Voltage: AC 220-240V 50Hz 35mA
- * 20,000hrs long life time
- * Instant start with full bright output flick free
- * Perfect replacement for 50 W incandescent Bulb
- * Low temperature, safety to touch
- * No UV or IR emission, mercury FREE
- * This lamp is not suitable for accent lighting

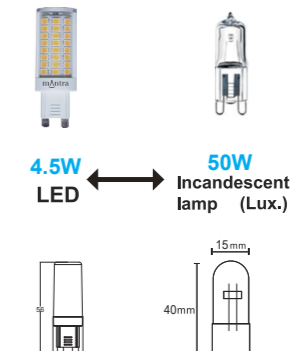

4.5W G9 520 Lumen

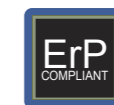

| Item No. | R09300 | R09301 |
|----------------------------------|---------------------|--------|
| Potencia nominal/Wattage(W) | 4.5 | 4.5 |
| Temperatura de color/CCT(K) | 3000K | 4000K |
| Flujo luminoso/Luminous Flux(lm) | 520 | 550 |
| Tensión nominal/Voltage(V) | AC 220-240V 50/60Hz | |
| Regulable/Dimmable | NO | |
| CRI | ≥80 | |
| Casquillo/Lamp Head | G9 | |
| Ángulo/Beam Angle(deg) | 360° | |
| Material | PC | |
| Dimensiones/Dimensions(mm) | Φ19*56 | |

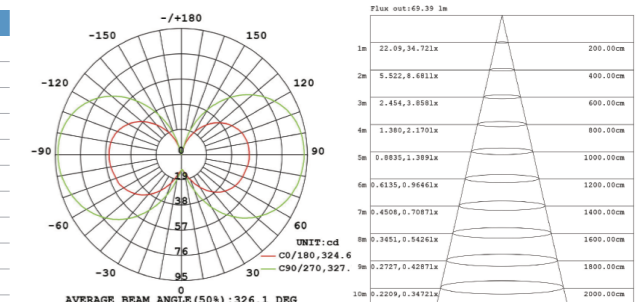

mAnttra
siente la luz

UK & Ireland

INSPIRED LIGHTING LTD.

Sefton Street, Heywood - OL10 2JF.

United Kingdom

Tel: +44 (0) 1706 62 00 77

sales@inspired-lighting.co.uk

Middle East

THE INSPIRED LIGHTING LLC.

26th Street, Al Quoz Industrial 4, Dubai.

UAE NG: 40R CN 22633 79197

Tel : +971 (0) 4 3466917

salesuae@inspired-lighting.co.uk

Sales Office Open : Mon - Sat: 9:00am - 6:30pm



SEE OUR YOUTUBE CHANNEL



www.inspired-lighting.co.uk